

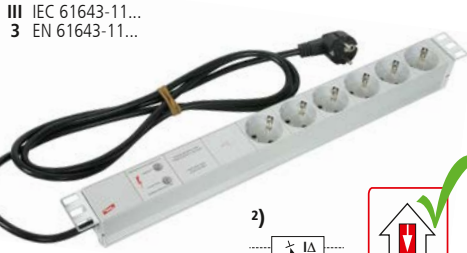

SFL PROTECTOR SFL PRO 6X 19"

- DE Einbauanleitung
- GB Installation instructions
- IT Istruzioni di montaggio
- FR Instructions de montage
- NL Montagehandleiding
- ES Instrucciones de montaje
- PT Instruções de montagem
- DK Monteringsvejledning
- SE Monteringsanvisning
- FI Asennusohje
- GR Οδηγίες συναρμολόγησης
- PL Instrukcja montażu
- CZ Montážní návod
- TR Kurulum Talimatları
- RU Инструкция по монтажу
- CN 安装说明
- HU Szerelési útmutató
- JP 設置説明書



III IEC 61643-11...
3 EN 61643-11...

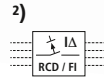
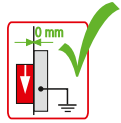
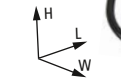

Technical Data / Technische Daten

SFL PRO 6X 19"	
$U_N / \text{Tol.: } 0V \dots U_C$	230 V (50/60 Hz)
U_C	255 V (50/60 Hz)
I_L	16 A~
max. I_{sc}	B16 A
I_{SCCR}	1.5 kA _{rms}
ϑ°	-20°C ... +40°C
Φ	5% ... 95%
I_{PE}	≤ 0.2 A
IP 1)	20
L x W x H	437 mm x 44 mm x 44 mm

Mounting / Montage

Example front mounting 19" rack
Beispiel Frontmontage 19"-Rack

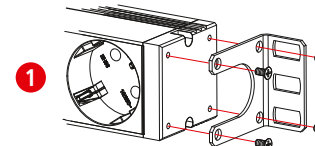

Mounting bracket can be turned by 90°
Haltewinkel um je 90° Grad drehbar

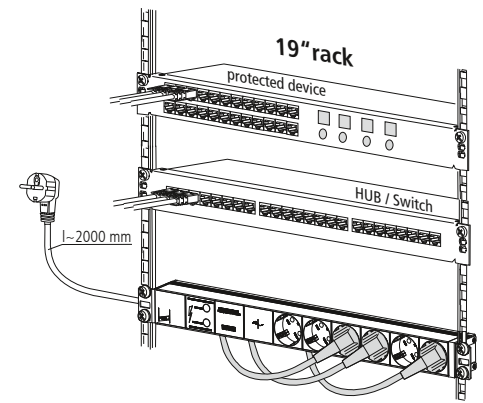
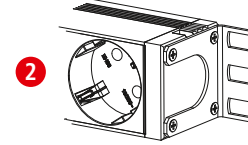

Safety / Sicherheit



socket outlet with earthing contact
Steckdose mit Erdungskontakt

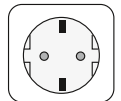

socket outlet without earthing contact
Steckdose ohne Erdungskontakt



de-energised only if disconnected from power supply
Spannungsfrei nur bei gezogenem Stecker

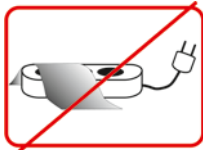
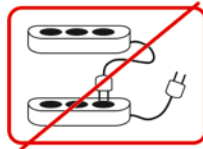

Basic circuit diagram / Prinzipschaltbild

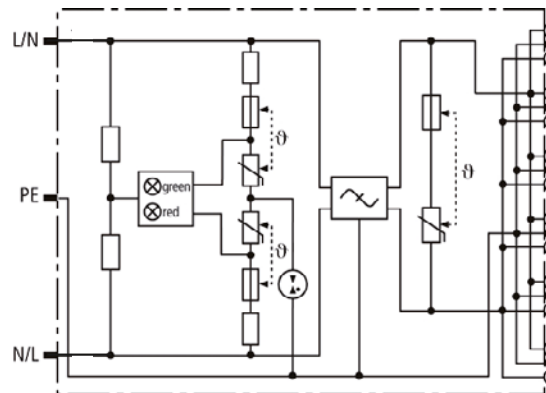

Coordination / Koordination

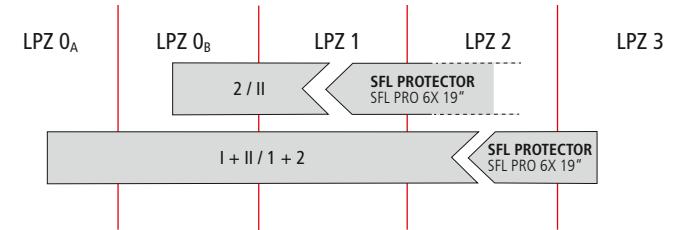

Operating state, Fault Indicator / Funktions-, Defektanzeige

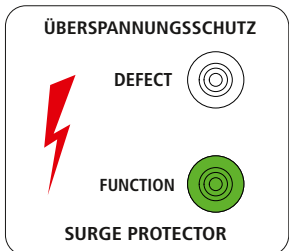

continuous operating voltage 230 V~
Betriebsspannung 230 V~

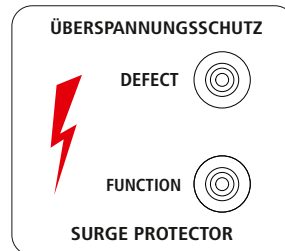

continuous operating voltage 0 V~
Betriebsspannung 0 V~



check fuse
Sicherung prüfen

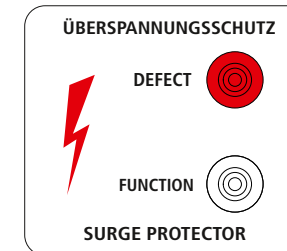

www.dehn.de
www.dehn-international.com

